

# PRIMARY AND FUSIBLE WIRE

*Photos not actual size*



## Primary Wire

Standard PVC Insulation (SE/GPT Type)  
Suitable for most automotive applications.  
Free of stripping, abrasion resistant,  
meets most O.E.M. vehicle standards

UNIT PACKAGE: 1 Roll

The lower the gauge number, the thicker the wire  
(i.e. 10 gauge is thicker than 16 gauge)

Gauge	Stranding	Outer Diameter	Auveco Part No.				Length
			Red	White	Black	Blue	
18	16 x 30	.092	<b>20486</b>	<b>20487</b>	<b>20488</b>	<b>20489</b>	45 Ft.
16	19 x 29	.104	<b>20490</b>	<b>20491</b>	<b>20492</b>	<b>20493</b>	35 Ft.
12	19 x 25	.142	<b>20494</b>	<b>20495</b>	<b>20496</b>	<b>20497</b>	15 Ft.
10	19 x 23	.175	<b>20498</b>	<b>20499</b>	<b>20500</b>	<b>20501</b>	10 Ft.

## 25 Foot Spool

Gauge	Stranding	Outer Diameter	Auveco Part No.					Yellow
			Red	White	Black	Blue	Green	
14	19 x 27	.117	<b>12419</b>	<b>12420</b>	<b>12421</b>	<b>12422</b>	<b>15239</b>	<b>15240</b>

## 100 Foot Spool

Gauge	Stranding	Outer Diameter	Auveco Part No.						
			Red	White	Black	Blue	Green	Yellow	Brown
20	10 x 30	.085	<b>21339</b>	<b>21340</b>	<b>21341</b>	<b>21342</b>	<b>21343</b>	<b>21344</b>	<b>21345</b>
18	16 x 30	.092	<b>12423</b>	<b>12424</b>	<b>12425</b>	<b>12426</b>	<b>12427</b>	<b>12428</b>	<b>15256</b>
16	19 x 29	.104	<b>12429</b>	<b>12430</b>	<b>12431</b>	<b>12432</b>	<b>12433</b>	<b>12434</b>	<b>15257</b>
14	19 x 27	.117	<b>12435</b>	<b>12436</b>	<b>12437</b>		<b>12439</b>	<b>12440</b>	<b>15258</b>
12	19 x 25	.142	<b>12441</b>	<b>12442</b>	<b>12443</b>	<b>12444</b>	<b>15259</b>	<b>15260</b>	
10	19 x 23	.175	<b>12445</b>		<b>12447</b>	<b>12448</b>		<b>15263</b>	

## Spooled Fusible Link Wire

The lower the gauge number, the thicker the wire (i.e. 10 Ga. is thicker than 16 Ga.)



A fusible link is a special section of low tension cable installed by an OEM and designed to open a circuit when subjected to extreme current overload. Its purpose is to minimize wiring system damage when such an overload accidentally occurs in those circuits protected by the fusible link. A short circuit causes the fusible link to act as an element in a "slow-blow" fuse. A fusible link is not intended to be used in place of a fuse but only where a fuse cannot be economically employed. Our fusible line wire meets the requirements of SE J-156 and the insulation has the characteristics as listed for EAE, SE J-1128 Type SXL. The vehicle manufacturer should be consulted about questions on fusible link length and size. General practice has been for a fusible link to be 4 gauges smaller than the circuit wire.

*Example:* if the circuit wire is 12 gauge, use a 16 gauge fusible link.

Final determination should be based on O.E.M. application.

*Note:* Extreme care should be taken to always replace a fusible link with then same gauge and length as installed by the manufacturer.

Auveco Part No.	Gauge	Color	Length	Replaces	Unit Pkg.
<b>15372</b>	14	Orange	25 Ft.	GM: 6292995	1 Spool
<b>20484</b>	8	Black or Rust	25 Ft.		1 Spool

\*Color may vary at manufacturer's option

**FUSIBLE LINKS**

*Photos not actual size*



**Universal Fusible Links**

Auveco Part No.	Gauge	Length	Replaces	Unit Pkg.
12627	18	9"	Chry: 3843392 & other 18 Ga. links	5
12628	16	9"	GM: 6292996, 8903489 Ford D3AZ-14526-E & other 16 Ga. links	5
12629	14	9"	GM: 6292995, 8903488 Ford D3AZ-14526D & other 14 Ga. links	5
17465	12	9"	GM: 6293923	5
17464	10	9"	GM: 12077140	5

**TEST CLIPS**



Type 1

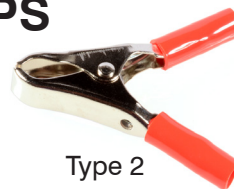

Type 2

Auveco Part No.	Type	Description	Unit Pkg.
20478	1	10 Amp, Alligator Clip, Nickel Plated, 2" Long	5
16969	2	10 Amp, Red Insulation, 2-1/4" Long	5
16970	2	10 Amp, Black Insulation, 2-1/4" Long	5
16971	2	1 Each of 16969 & 16970	1 Pair
16972	2	30 Amp, Red Insulation, 3" Long	5
16973	2	30 Amp, Black Insulation, 3" Long	5
16974	2	1 Each of 16972 & 16973	1 Pair
16975	2	50 Amp, Red Insulation, 3" Long	5
16976	2	50 Amp, Black Insulation, 3" Long	5
16977	2	1 Each of 16975 & 16976	1 Pair

**BATTERY CABLE & TERMINALS**



**Battery Cable**

Bare Copper Standard Conductor, covered with tough black Polyvinyl Chloride insulation. The thick jacket is easy to strip, resistant to moisture, weather, oil and acids.

Auveco Part No.	Gauge	Stranding	O.D.	Unit Pkg.
11392	4	70 x 22.5	.380	25' Roll
13850	1/0	133 x 21	.530	25' Roll
13851	2/0	133 x 20	.590	25' Roll

**Solderless Battery Cable Terminals**



Tin Plated Copper

Auveco Part No.	Cable Size	Post Size	Unit Pkg.
11360	No. 6 AWG	Universal	2
11361	No. 4 AWG	Universal	2
11362	No. 1 AWG	Positive	2
11363	No. 1 AWG	Negative	2
11364	No. 1/0 AWG	Positive	2
11365	No. 1/0 AWG	Negative	2
11366	No. 2/0 AWG	Positive	2
11367	No. 2/0 AWG	Negative	2
15858	No. 3/0 AWG	Positive	2

Note: Use with Auveco Tool No. 7996



**Universal Battery Terminal**

**9948**

For Positive & Negative Posts  
Cable Range 8 thru 2/0 AWG

UNIT PACKAGE: 2

**Marine Battery Terminals**

Lead Plated Brass Terminal  
Nickel Plated Grade 2 Steel Wing Nut  
Zinc Plated Grade 2 Steel Bolt & Nut



**8772**

For Positive Posts  
Stud: 3/8"-16

UNIT PACKAGE: 5



**8773**

For Negative Posts  
Stud: 5/16"-18

UNIT PACKAGE: 5

# BATTERY CABLE & TERMINALS

Photos not actual size

Sec. 12

## Engine Ground & Bonding Strap



**19499**

Replacement for body to engine block straps. Solves light dimming problems by grounding charging system. Also reduces radio noise. Copper braided wire with tin-plated brass ring terminals.

Length: 8"

Gauge: 10

Stud Size Ring Terminal: 5/16" - 3/8"

UNIT PACKAGE: 2

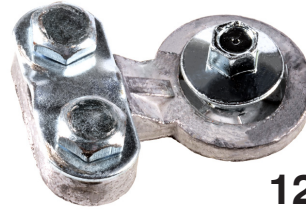

## Universal Side Mount Battery Cable Terminal

**12975**

Fits all small diameter cables - both positive and negative.

UNIT PACKAGE: 2



## All Lead Terminal

**10808**

Zinc Plated Steel Bolt & Nuts  
Stud: 5/16"-18

Universal Positive & Negative

UNIT PACKAGE: 2

# COMPRESSION BATTERY CABLE TERMINALS

All clamps and lugs are made of cast copper • All clamps, lugs and fasteners are tin plated

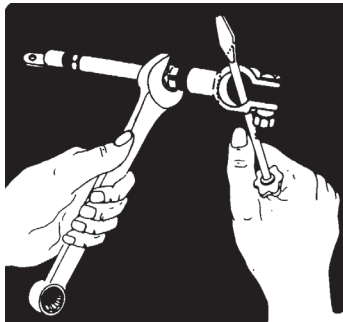

Assemble with common hand tools.

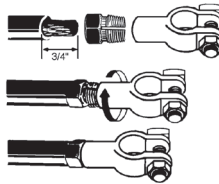

### Three Easy Steps

- Strip 3/4" of insulation from the end of the cable. Insert bared wire into the compression nut.
- Thread terminal on compression nut.
- Grip compression nut with wrench and turn the terminal until the compression nut seats. With larger gauges you may want to hold the terminal in a vise



## Straight Clamp

Auveco Part No.	Cable Gauge	Description.	Color	Unit Pkg.
15603	4	Pos.	Gray	2
15605	1&2	Pos.	Green	2
15606	1/0	Neg.	Black	2
15607	1/0	Pos.	Black	2
15608	2/0	Neg.	Orange	2
15609	2/0	Pos.	Orange	2
15610	3/0	Neg.	Purple	2
15611	3/0	Pos.	Purple	2



## Heavy Wall Copper Lug

Auveco Part No.	Cable Gauge	Hole Size	Color	Unit Pkg.
15618	4	3/8"	Gray	2
15619	1&2	3/8"	Green	2
15620	1/0	3/8"	Black	2
15621	1/0	1/2"	Black	2
15622	2/0	3/8"	Orange	2
15625	3/0	1/2"	Purple	2



## Stud/Side Terminal

Auveco Part No.	Cable Gauge	Color	Unit Pkg.
15628	1/0	Black	2



## Compression Nut



Auveco Part No.	Cable Gauge	Color	Unit Pkg.
15632	2/0	Orange	5

*Photos not actual size*



**Copper Battery Cable Lugs**

Auveco Part No.	Cable Size	Stud Size	Unit Pkg.
<b>5794</b>	4 Ga.	3/8"	25
<b>5796</b>	1/0 Ga.	3/8"	25
<b>11467</b>	2/0 Ga.	1/2"	10

Use Auveco 7996 Crimping Tool

**Heavy Duty Battery Cable Terminal Ends for Stud-Type Batteries**  
For Auto, Truck, Marine and H.D. Equipment



**Single Barrel**  
Copper/Plated  
Stud Size: 3/8

Auveco Part No.	Cable Size	Unit Pkg.
<b>13810</b>	1/0	2
<b>13811</b>	2/0	2

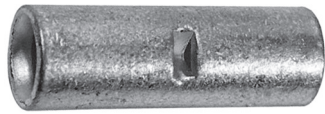

**Butt Connector (Double Flared)**

Pure Copper with Tin Plating

Applications: Field or shop splicing of battery cables and welding cables.

Auveco Part No.	Cable Size	Length	Unit Pkg.
<b>11729</b>	2/0 Ga.	1-3/4"	5



**Double Barrel**  
Copper/Plated  
Stud Size: 3/8

Auveco Part No.	Cable Size	Unit Pkg.
<b>13814</b>	2/0	1



**11083**  
(8917444)  
Zinc

Battery Side Terminal Bolt  
Thread Size: 3/8"-16  
Overall Length: 1-1/8"  
GM

UNIT PACKAGE: 10



**19199**  
(12004188)  
Zinc

Battery Side Terminal Bolt  
Thread Size: 3/8"-16  
Overall Length: 1-3/4"  
GM

UNIT PACKAGE: 5



**13816**  
Stainless Steel

Battery Hold Down Nuts  
Thread Size: 3/8-16  
Overall Length: 18/8

UNIT PACKAGE: 4

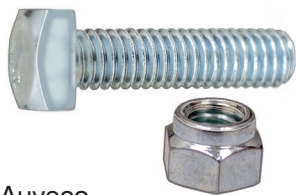

**Battery Terminal Bolt & Nut**  
Zinc Chromate

Auveco Part No.	Size	Unit Pkg.
<b>3186</b>	5/16"-18 x 1-1/4" Bolt w/Collared Nut	100
<b>8003</b>	5/16"-18 x 1-1/4" Bolt W/Hex Nut	50
<b>14974</b>	5/16"-18 x 1-1/4" Bolt Only	50
<b>14975</b>	5/16"-18 Collared Nut Only	50

**Suggested Terminal Assemblies**

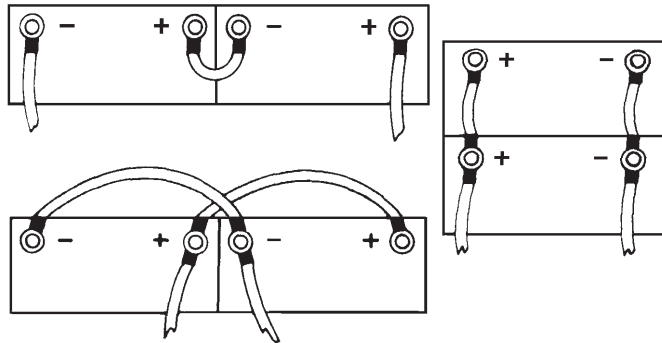

**20899**

Side Terminal Battery Cleaner

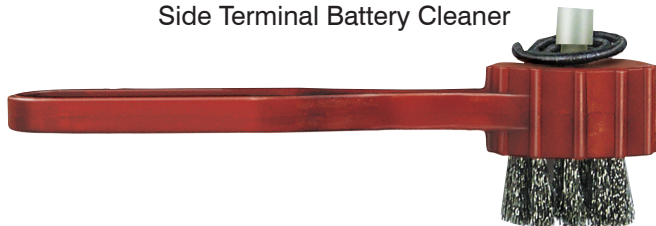

Coil spring cutters polish the battery contacts while the stainless steel brushes clean the cable terminals.

UNIT PACKAGE: 1

# BATTERY TERMINAL TOOLS

*Photos not actual size*



**20898**  
Battery Brush

Cleans dirt and corrosion from post type battery terminals and cable clamps. Made of heavy duty stainless steel wire. Case is made of high impact plastic that will not weaken in cleaning solutions.

UNIT PACKAGE: 1



**15039**  
Anti-Corrosion Protectant

A non-drying coating protectant, formulated especially for battery terminals and other exposed electrical connections.

UNIT PACKAGE: 1 8oz. Can



**7996**

Crimps cable range  
Gauge: 8 to 4/0  
Use with vise or hammer

UNIT PACKAGE: 1

**3M Vinyl Electrical Tape**  
*Made in U.S.A.*



.007" Thick x 3/4" Wide x 60 Ft. Long

**16527:** Unit Package: 5 Rolls  
**16578:** Unit Package: 15 Rolls

General purpose vinyl insulating tape with excellent resistance to abrasion, moisture, alkalis, acid, copper corrosion and varying weather conditions. Can be used as a primary electrical insulation for all wire and cable splices rated up to 600 volts.

**Linerless Self-Bonding Rubber Tape**



**14389**

.030" Thick x 3/4" Wide x 15ft. Long

UNIT PACKAGE: 1 Roll

Replace heat shrink tubing with a safe, tight, long-lasting seal that withstands temperature extremes from -50° to 300°F. No heat guns or open flames needed. No paper liner to mess with.

Tape is stretched when applied and retains its elasticity to ensure a tight seal at all points. The tape is unaffected by salt spray and common automotive fluids. As long as it is stretched when it is applied, it will not unravel after application due to its self-bonding characteristics.

## CIRCUIT BREAKERS

Automatic Re-Set

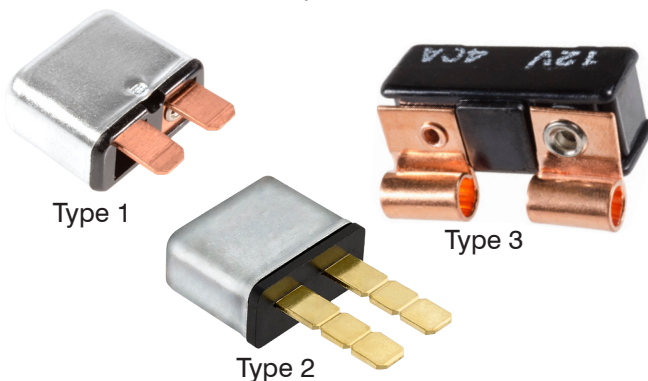

Auveco Part No.	Type	Specifications	Unit Pkg.
<b>15046</b>	1	30 Amps at 12 Volts	5
<b>18518</b>	2	10 Amps at 12 Volts	2
<b>18519</b>	2	15 Amps at 12 Volts	2
<b>18520</b>	2	20 Amps at 12 Volts	2
<b>18521</b>	2	30 Amps at 12 Volts	2
<b>18522</b>	2	40 Amps at 12 Volts	2
<b>15048</b>	3	30 Amps at 12 Volts	5
<b>15049</b>	3	40 Amps at 12 Volts	5

# HEAT SHRINK TUBING

Made in the U.S.A. • Photos not actual size



## Black Thin Wall Heat Shrink Tubing

- 2 to 1 Shrink Ratio
- Cross linked Polyolefin
- Highly Flame Retardant (VW-1)

Auveco Part No.	Size	Pre-Shrink I.D.	Post-Shrink I.D.	Length	Unit Pkg.
18693	3/64"	.046"	.023"	6"	25
18694	1/16"	.063"	.031"	6"	25
18695	3/32"	.093"	.046"	6"	25
18696	1/8"	.125"	.062"	6"	25
18697	3/16"	.187"	.093"	6"	25
18698	1/4"	.250"	.125"	6"	25
18699	3/8"	.375"	.187"	6"	15
18700	1/2"	.500"	.250"	6"	15
18701	3/4"	.750"	.375"	6"	10
18702	1"	1.00"	.500"	6"	10
18703	1-1/2"	1.50"	.750"	6"	5



## Adhesive Lined Heat Shrink Tubing

- 4.5 to 1 Shrink Ratio
- Cross linked, Semi-Rigid Polyolefin Outer Jacket
- Hot-Melt Adhesive Inner Wall adheres to all major types of Wire
- Environmentally Seals & Insulates
- Meets O.E.M. Specs: Ford: ESB M99 D56 A1 Chrysler: MS-DB56

Auveco Part No.	Pre-Shrink I.D.	Post-Shrink I.D.	Length	Color	Unit Pkg.
18705	.225"	.050"	3-1/2"	Black	10
18706	.293"	.065"	3-1/2"	Black	10
18707	.427"	.095"	3-1/2"	Black	10
18708	.700"	.175"	3-1/2"	Black	5



## Adhesive Lined Dual Wall Self-Sealing Heat Shrink Tubing

- 3 to 1 Shrink Ratio
- Excellent Insulating, Abrasion-Resisting & Strain Relief Properties
- Provides Waterproofing & Environmental Protection

Auveco Part No.	Size	Pre-Shrink I.D.	Post-Shrink I.D.	Length	Color	Unit Pkg.
16665	22-14 Gauge	.188"	.062"	12"	Black	4
16666	12-10 Gauge	.250"	.083"	12"	Black	4
18733	14-10 Gauge	.400"	.150"	6"	Black	4
19102	14-10 Gauge	.400"	.150"	6"	Black	25
18734	14-10 Gauge	.400"	.150"	6"	Red	4
19103	14-10 Gauge	.400"	.150"	6"	Red	25
18735	8-1 Gauge	.750"	.220"	6"	Black	4
19104	8-1 Gauge	.750"	.220"	6"	Black	25
18736	8-1 Gauge	.750"	.220"	6"	Red	4
19105	8-1 Gauge	.750"	.220"	6"	Red	25
18737	2-4/0 Gauge	1.100"	.375"	6"	Black	4
19106	2-4/0 Gauge	1.100"	.375"	6"	Black	25
18738	2-4/0 Gauge	1.100"	.375"	6"	Red	4
19107	2-4/0 Gauge	1.100"	.375"	6"	Red	25

## Heat Shrink Tubing Kit

Auveco Part No.	Qty.	Pre-Shrink Size	Post-Shrink I.D.	I.D.
18697	36	3/16"	.187"	.093"
18698	24	1/4"	.250"	.125"
18699	12	3/8"	.375"	.187"
18700	6	1/2"	.500"	.250"
18701	4	3/4"	.750"	.375"
18702	4	1"	1.00"	.500"

UNIT PACKAGE: 1

## 18887

Six inch lengths of black thin wall, cross linked polyolefin, heat shrink tubing in a durable translucent polypropylene box. The tubing has 2:1 shrink ratio.



# FUSE HOLDERS & ACCESSORIES

*Photos not actual size*

**Sec. 12**

**12592**

Nylon



Glass Tube Fuse Puller

UNIT PACKAGE: 1

**12079**

Nylon



Moulded In-Line Fuse Holder with 8" of 18 Gauge Wire  
Use with Auveco 1/4" x 1-1/4" Glass Tube Fuses  
Up to and including 20 Amps

UNIT PACKAGE: 3

**11618**

Nylon



Fuse Assembly with 30 Amp Fuse Included  
12 Gauge Wire

UNIT PACKAGE: 5

**18103**

Tests ATO® (Blade Type) and Mini-Fuses.

Now you can make sure the fuse is good before installing it.

Also functions as a fuse puller.  
40 Amp maximum

UNIT PACKAGE: 1

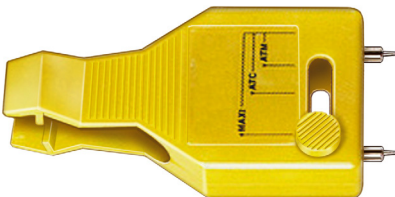

**12359**

In-Line Fuse Holder

Accommodates all ATO/ATC fuses from 3-30 Amps  
Heavy Duty Hard Shell Construction  
10" Loop of 14 Gauge Wire

UNIT PACKAGE: 3

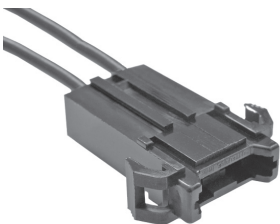

**14055**

In-Line Fuse Holder

Accommodates all ATO/ATC fuses from 3-30 Amps Heavy Duty Hard Shell Construction  
10" Loop of 12 Gauge Wire

UNIT PACKAGE: 3

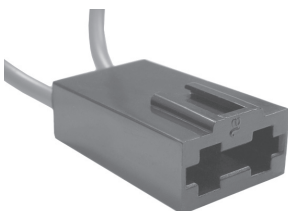

**12363**

In-Line Fuse Holder

Accommodates all ATO/ATC fuses from 3 thru 20 Amps. Comes with two 4" 16 Gauge Wire Leads.

UNIT PACKAGE: 5

**20789**

In-Line Mini Fuse Holder



30 Amp Maximum  
12 Gauge Wire

Use with Auveco Mini Fuses 16351-16360  
Replaces Auveco 17648 Fuse NOT Included

UNIT PACKAGE: 3

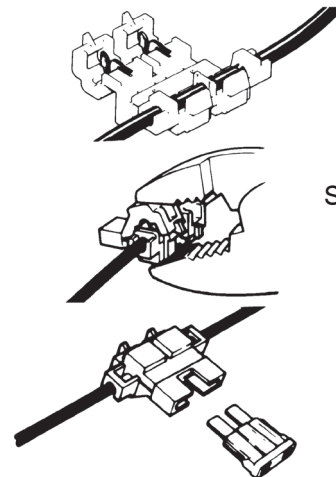

**12977**

Self-Stripping Fuse Holder

Mates with most plug-in blade type fuses found in late-model domestic and some import cars.  
For 18-14 gauge copper wire.

32 volts maximum  
20 amp maximum with 14 gauge wire  
10 amp maximum with 16 gauge wire  
7.5 amp maximum with 18 gauge wire

UNIT PACKAGE: 5

*Photos not actual size*

**Sealed Fuse Holders For ATM Mini® Fuses**



**20206**

20, 25 & 30 Amp Capacity  
10" Long 12 Gauge Cross-Linked Polyethylene Leads  
Fuse NOT Included

UNIT PACKAGE: 1



**20207**

2-15 Amp Capacity  
10" Long 16 Gauge Cross-Linked Polyethylene Leads  
Fuse NOT Included

UNIT PACKAGE: 1

**High Power Sealed Fuse Holder**

**20320**

For ATC & ATO Fuses  
40 Amp Capacity  
12" Long 10 Gauge 105 Strand  
EZ Flex Wire Leads  
Fuse NOT Included

UNIT PACKAGE: 1

**Environmentally Sealed Blade Type Fuse Holder**

Also used as Fuel Pump Fuse Holder on GM Vehicles

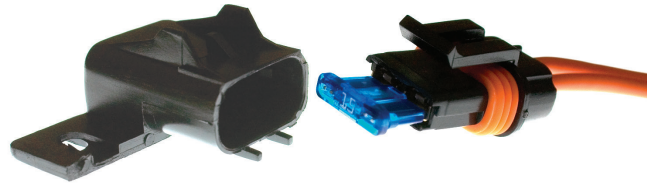

**13686**

(GM: 12101917; Delco: PT-189)

UNIT PACKAGE: 1

Electrical system protection for fleets, construction equipment, aircraft service vehicles, outdoor power equipment and marine installations.

Resistant to moisture, salt spray and engine compartment fluids. Withstands 50g physical shock. Operating temperature range from -40° to 125°C.

- Nylon Body with Latching Cap
- Silicone Rubber Seals at Wires and Cap
- 12 Gauge SE/GPT Wire Leads
- 3 to 30 Amp Capacity - Type ATC/ATO Fuses
- 5" Long Wire Leads
- Fuses NOT included

**Low Profile JCase Fuses**



Auveco Part No.	Amp Rating	Color	Unit Pkg.
21472	20	Blue	3
21473	25	White	3
21474	30	Pink	3
21106	40	Green	3
21475	50	Red	3
21476	60	Yellow	3

**PAL™ (Pacific Auto Link) Fuses**



Type 1

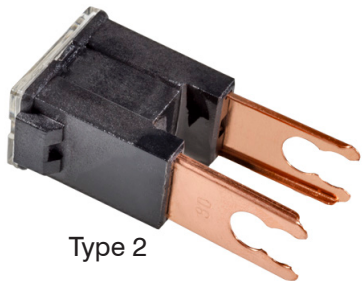

Type 2



Type 3



Type 4

Auveco Part No.	Type	Amp Rating	Color	Unit Pkg.
20560	1	20	Blue	1
15926	1	30	Pink	1
15927	1	40	Green	1
19294	1	50	Red	3
15928	1	60	Yellow	1
15929	2	30	Pink	1
15930	2	60	Yellow	1
15931	2	80	Black	1
15932	3	30	Pink	1
15933	3	40	Green	1
19295	3	80	Black	2
19296	3	100	Blue	2
20551	4	20	Blue	2
20552	4	30	Pink	2
20553	4	40	Green	2
20554	4	50	Red	2
20555	4	60	Yellow	2



*Photos not actual size*

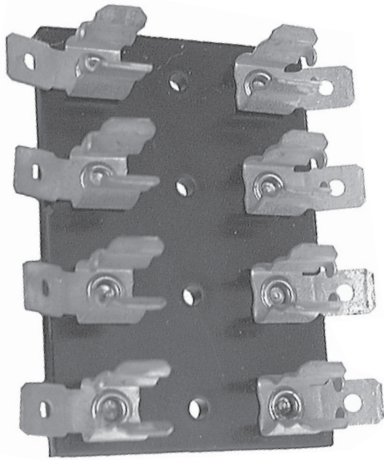

## 13445

Four Gang Fuse Block

Size: 2-7/16" x 2-15/16" x 3/4"

For use with SFE-20 Amp. fuse or any 3 AG series fuse. Phosphor bronze fuse clips. Brass screws

UNIT PACKAGE: 1

## Terminal/Junction Blocks



For marine and exposed applications. Brass nickel plated terminal links and binding head terminal screws. Moisture repellent molded ABS base with protective insulator barrier strips. 20 Amp rating.

## 13446

4 Gang (Circuits)

Size: 3-1/4" x 1-5/16" x 5/8"

UNIT PACKAGE: 1

## 13447

6 Gang (Circuits)

Size 3-3/8" x 1-1/8" x 9/16"

UNIT PACKAGE: 1

## 13449

10 Gang (Circuits)

Size: 5-1/8" x 1-1/8" x 9/16"

UNIT PACKAGE: 1



## 14474

Blade Type Fuse Tap

A quick, easy alternative to direct wiring when tapping the "hot side" of the fuse block. The blade type fuse tap is made of sturdy brass and is engineered for quick connect and disconnect of accessories such as C.B. radios, hand-held lights, etc.

UNIT PACKAGE: 25

Installation can be completed in three steps:

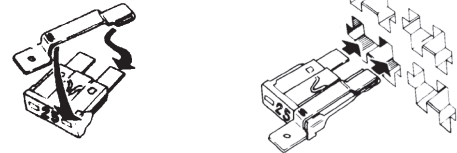

1. Use a test probe to locate the "hot side" of the circuit in the fuse block. Then snap the tap over the corresponding "hot side" blade of the fuse. Insert the fuse into the fuse block.

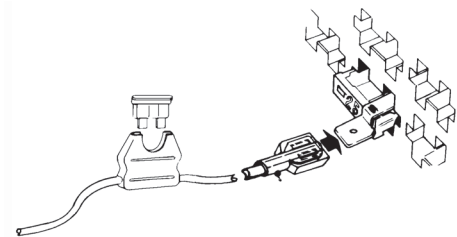

2. Crimp one end of an in-line fuse holder (with the fuse installed) to a fully insulated nylon .250" female quick-connect terminal. Attach the other fuse holder lead to the accessory wire.

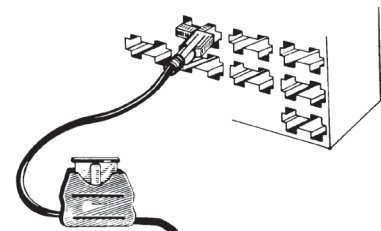

3. Complete the connection by sliding the female quick-connect terminal onto protruding tab of the tap.



## 17686

Mini Fuse Blade Type Fuse Tap

"Tapping" fuse blocks equipped with Mini® Fuses are no Problem!

Now there's a quick, easy alternative to direct wiring for tapping the "hot side" of mini fuse style fuse blocks. The blade type fuse tap is made of .016" thick sturdy brass with a .187" (3/16") wide tab. It is engineered for quick connect and disconnect of accessories.

UNIT PACKAGE: 50

Installation can be complete in 3 steps:



1. Locate "hot side" of circuit in fuse block with a test probe. Slide the tap onto corresponding "hot side" blade of fuse.

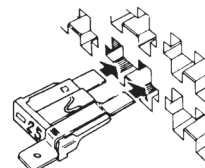

2. Insert the fuse into the fuse block

3. Crimp one end of an in-line fuse holder (with the fuse installed) to the appropriate Auveco female connector 8781 (16-14 Ga.) or 12159 (22-18 Ga.). Attach the other fuse holder lead to the accessory wire. Slide the female connector onto protruding tab of the tap.

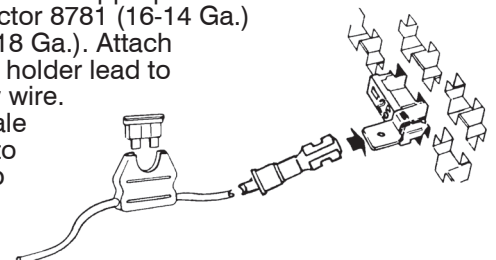

**ATC®/ATO®  
(Blade Type) Fuses**



Auveco Part No.		Amp Rating	Color
Unit Pkg. 5	Unit Pkg. 25		
12534	12548	3	Violet
12535	12549	4	Pink
12536	12550	5	Tan
12537	12551	7-1/2	Brown
12538	12552	10	Red
12539	12553	15	Blue
12540	12554	20	Yellow
12541	12555	25	White
12542	12556	30	Green

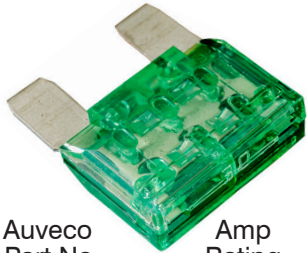

**Maxi™  
Fuses**

Auveco Part No.	Amp Rating	Color	Unit Pkg.
15505	20	Yellow	2
15506	30	Green	2
15507	40	Orange	2
15508	50	Red	2
15509	60	Blue	2



**Low Profile  
Mini Fuses**

Auveco Part No.	Amp Rating	Color	Unit Pkg.
21602	5	Tan	5
21603	7.5	Brown	5
21436	10	Red	5
21437	15	Blue	5
21166	20	Yellow	5
21438	25	Clear	5
21604	30	Green	5

**Mega® Fuses**



Auveco Part No.	Amp Rating	Unit Pkg.
21598	40	2
21599	60	2
21600	80	2
18986	100	2
18987	125	2
18988	150	2
18989	175	2
18990	200	2
22118	250	2
22119	300	2
22120	500	2

**FUSES**

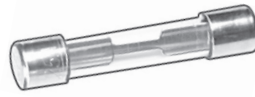

**Glass Tube  
Fuses**

Auveco Part No.	Size	Amp	Code	Unit Pkg.
18981	1/4" x 1-1/4"	2	AGC-2	5
17625	1/4" x 1-1/4"	3	AGC-3	5
17626	1/4" x 1-1/4"	5	AGC-5	10
17627	1/4" x 1-1/4"	7.5	AGC-7.5	10
12545	1/4" x 1-1/4"	10	AGC-10	5
12546	1/4" x 1-1/4"	15	AGC-15	5
18982	1/4" x 1-1/4"	20	AGC-20	5
12543	1/4" x 1-1/4"	20	SFE-20	5
18983	1/4" x 1-1/4"	25	AGC-25	5
12544	1/4" x 1-7/16"	30	SFE-30	5
12547	1/4" x 1-1/4"	30	AGC-30	5



**Mini® Fuses**

Auveco Part No.	Amp Rating	Color	Unit Pkg.
16351	2	Gray	5
16352	3	Purple	5
16353	4	Pink	5
16354	5	Tan	5
16355	7.5	Brown	5
16356	10	Red	5
16357	15	Blue	5
16358	20	Yellow	5
16359	25	White	5
16360	30	Green	5



**Micro Fuses  
2 Blades**

Auveco Part No.	Amp Rating	Color	O.E.M No.	Unit Pkg.
21828	5	Tan	GM: 19209790	5
21829	7.5	Brown	GM: 19209791	5
21830	10	Red	GM: 19209792	5
21831	15	Blue	GM: 19209793	5
21832	20	Yellow	GM: 19209794	5
21833	25	Natural	GM: 19209795	5
21834	30	Green	GM: 19209796	5



**Micro Fuses  
3 Blades**

Auveco Part No.	Amp Rating	Color	O.E.M No.	Unit Pkg.
21749	5	Tan	Ford: DG9Z-14526-N GM: 19209797	2
21750	7.5	Brown	Ford: DG9Z-14526-S GM: 19209798	2
21751	10	Red	Ford: DG9Z-14526-P GM: 19209799	2
21752	15	Blue	Ford: DG9Z-14526-R GM: 19119304	2

Use with butt connectors on pages 205-211 • *Photos not actual size*



### 9905

(Chry: 2496279; GM: 2973932;  
AMC: 3509575; IHC: 374985C1)

Instrument Panel Socket for 5/8" Hole  
Bulb No. 158, 194, 194A  
GM, Chrysler, AMC & International

UNIT PACKAGE: 10



### 12237

(Chry: 3744750; GM: 12004311,  
25015169; Ford: C80Z-13711A)

Instrument Panel Socket for 1/2" Hole  
Bulb No. 158, 194, 194A  
GM, Ford & Chrysler

UNIT PACKAGE: 2



### 9883

(GM: 6298886,  
6298892, 6298935;  
Ford: D0DZ-15A434B)

Side Marker Assembly  
Bulb No. 158, 194, 194A  
GM & Ford

UNIT PACKAGE: 5

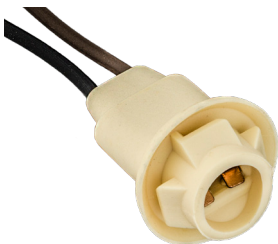

### 11441

Instrument Panel and  
Marker Lights  
Bulb No. 158, 194, 194A  
GM & Ford

UNIT PACKAGE: 10

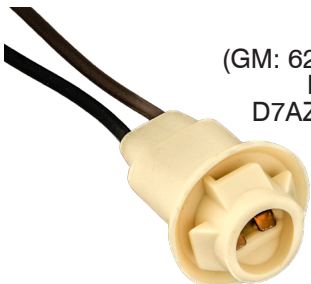

### 11166

(GM: 6294015, 8901283, 8918527;  
Ford: D40Z-13410E,  
D7AZ-13412A, D7FZ-13412A)

Side Marker and  
License Plate Lights  
Bulb No. 158, 194, 194A  
GM & Ford

UNIT PACKAGE: 1



### 13540

(8912750)

Side Marker, License,  
Parking & Tail Lights  
Bulb No. 158, 194, 194A  
GM

UNIT PACKAGE: 1

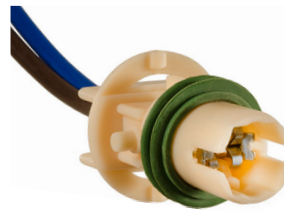

### 17108

(12083007)

Marker Light Pigtail  
Bulb No. 24  
GM 1988-On

UNIT PACKAGE: 1

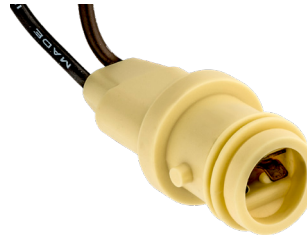

### 18924

(12083460)

Rear Side Marker Lights  
Bulb No. 158, 194, 194A  
GM 1985-On

UNIT PACKAGE: 1

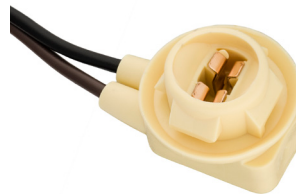

### 13549

(12001470)

Side Marker, License,  
Tail & Stop Lights  
Bulb No. 158, 194, 194A  
GM

UNIT PACKAGE: 1

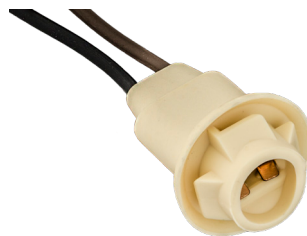

### 13558

(6298892, 6298886)

Side Marker Assembly  
Bulb No. 158, 194, 194A  
GM

UNIT PACKAGE: 1



### 8755

(2978302)

License Plate, Back-Up  
& Instrument Panel Lights  
For 1-1/8" Hole  
Bulb No. 63, 67, 81, 87, 89, 93,  
209, 1003, 1073, 1129, 1133 & 1141  
GM

UNIT PACKAGE: 10

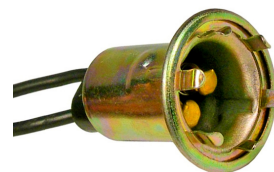

### 8759

Signal, Park, Stop  
& Tail Lights  
For 3/4" Hole  
Bulb No. 198, 1016,  
1034, 1154 & 1157  
GM

UNIT PACKAGE: 5

Use with butt connectors on pages 205-211 • *Photos not actual size*



**8756**

(2974309)

Signal, Park, Stop & Tail Lights  
For 1-1/8" Hole  
Bulb No. 198, 1016, 1034, 1154 & 1157  
GM

UNIT PACKAGE: 10



**13544**

(12003878, 8904251)

Back-up, Cornering  
& Turn Signal  
Bulb No. 1156  
GM

UNIT PACKAGE: 1



**8754**

Weatherproof Signal,  
Park, Stop & Tail Lights  
For 3/4" Hole  
Bulb No. 198, 1016, 1034, 1154 & 1157  
GM

UNIT PACKAGE: 5

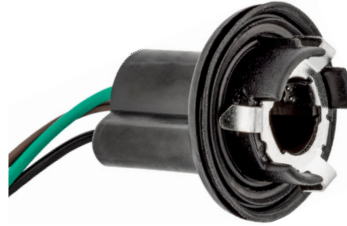

**11446**

(8902487, 8903283,  
8907701 & 8909908)

Stop & Tail Lights  
Bulb No. 1157  
GM

UNIT PACKAGE: 5

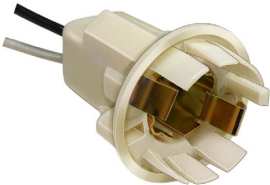

**8750**

(2974309, 2983540,  
6299087 & 8912698)

Signal, Park, Stop & Tail Lights  
Bulb No. 1034, 1154 & 1157  
GM

UNIT PACKAGE: 5

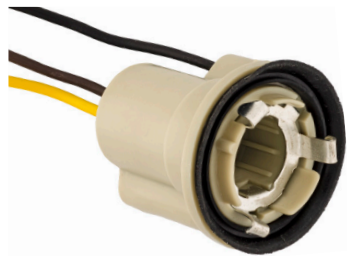

**11154**

(8903202, 8914822)

Park, Stop & Tail Lights  
Bulb No. 1034,  
1154 & 1157  
GM

UNIT PACKAGE: 1

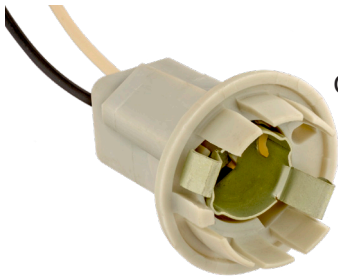

**11157**

(AMC: 4486948;  
GM: 2983540, 8912698;  
6299087)

Signal, Park, Stop  
& Tail Lights  
Bulb No. 1034,  
1154 & 1157  
GM & AMC

UNIT PACKAGE: 1



**11475**

(8903202, 8914822)

Park, Stop & Tail Lights  
Bulb No. 1034, 1154 & 1157  
GM

UNIT PACKAGE: 5

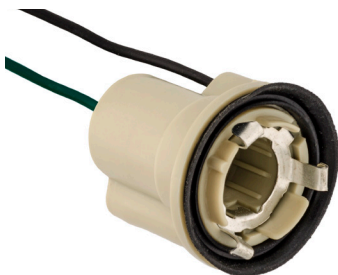

**11156**

(GM: 5963268,  
8904437, 8909518;  
IHC: 57172C91)

Back-up & Cornering  
Bulb No. 1156  
GM & IHC

UNIT PACKAGE: 1



**21006**

(15306157)

White Shell, Natural Insert

Daytime Running Lights  
& Turn Signal  
Bulb No. 3156 & 4156  
GM 1999 - On

UNIT PACKAGE: 1

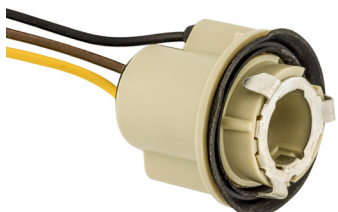

**11476**

(8903203, 8914823)

Park, Stop & Tail Lights  
Bulb No. 1157  
GM

UNIT PACKAGE: 5

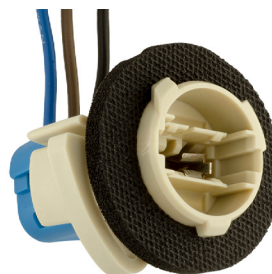

**17175**

(12076946)

Ivory Shell

Stop, Tail, Turn &  
Parking Lights  
Bulb No. 3057 & 3157  
GM 1988-On

UNIT PACKAGE: 1

# GM SOCKET ASSEMBLY & HARNESS CONNECTORS

Use with butt connectors on pages 205-211 • *Photos not actual size*

**Sec. 12**

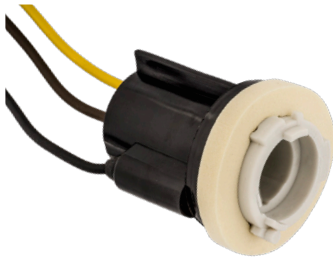

**13543**  
(8919916,12013813)

Park, Stop &  
Tail Lights  
Bulb No. 1157  
GM

UNIT PACKAGE: 1

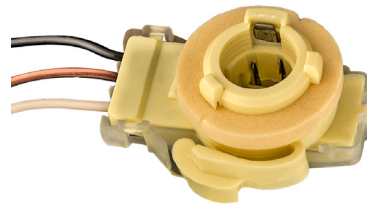

**13546**  
(12003757)

Signal & Park Lights  
Bulb No. 198 & 2057  
GM

UNIT PACKAGE: 1



**16585**  
(12083005)

Signal, Park, Stop & Tail Lights  
Dual Filament Wedge Base  
Bulb No. 3057  
GM

UNIT PACKAGE: 1

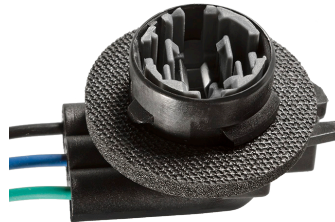

**17172**  
(12083680)  
Black Shell

Stop, Tail, Turn  
& Parking Lights  
Bulb No. 3057 & 3157  
GM: 1989-On

UNIT PACKAGE: 1



**16586**  
(12083006)

Signal, Park, Stop &  
Tail Lights  
Dual Filament Wedge Base  
Bulb No. 3057  
GM

UNIT PACKAGE: 1



**17173**  
(12083689)  
Ivory Shell

Stop, Tail, Turn  
& Parking Lights  
Bulb No. 3057 & 3157  
GM 1990-On

UNIT PACKAGE: 1



**18923**  
(12027133)

Back-Up Lights  
GM 1982-On

UNIT PACKAGE: 1



**17174**  
(12085330)  
Brown Shell

Back-Up Lights  
Bulb No. 2456 & 3156  
GM 1990-On

UNIT PACKAGE: 1

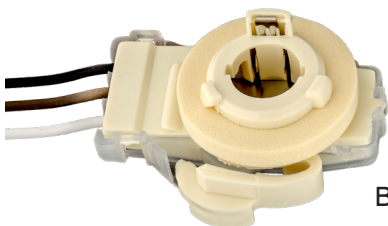

**12600**  
(GM: 12003759;  
AMC: 812893)

90° Pigtail &  
Socket Assembly  
Bulb No. 1016, 1034,  
1154 & 1157  
GM & AMC

UNIT PACKAGE: 1



**14918**  
(12048369)

Headlight Socket Assembly  
for High-Low 9004 & 9007  
Halogen Bulb  
GM, Ford & Imports

UNIT PACKAGE: 1

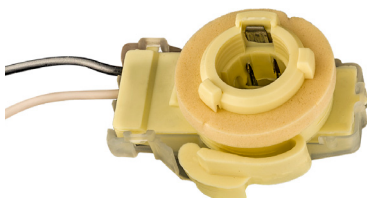

**13545**  
(12003758)

Tail Lights  
Single Contact  
Bulb No. 87, 93 & 1156  
GM

UNIT PACKAGE: 1

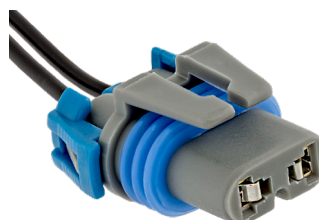

**16174**

Headlight Socket Assembly  
For Low Beam 9006  
Halogen Bulb  
Single Indexing Groove  
GM, Ford, AMC & Imports

UNIT PACKAGE: 4

Use with butt connectors on pages 205-211 • *Photos not actual size*

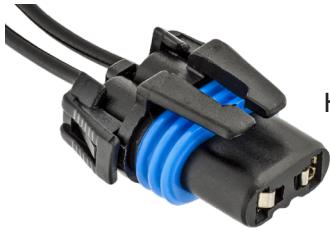

**16175**  
(GM: 12101898)

Headlight Socket Assembly  
For High Beam 9005  
Halogen Bulb  
Two Indexing Grooves  
GM, Ford, AMC & Imports

UNIT PACKAGE: 4



**18867**  
(12101880)

Direct Ignition  
Harness Connector  
GM  
1987-On

UNIT PACKAGE: 1



**16967**  
(12101906)

Heater Blower connector  
pigtail on GM 1985-On.  
Can also be used as  
an ATO/ATC Fuse Holder.  
Features two 9" long 12 gauge  
GXL wire leads.

UNIT PACKAGE: 1

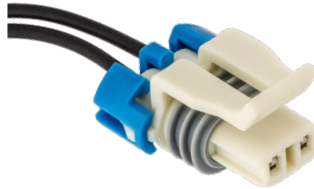

**18318**  
(12101857)

Air Divert Valve  
Harness Connector  
GM 1994-87

UNIT PACKAGE: 1

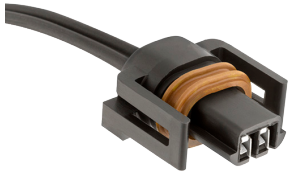

**17114**  
(12085496)

Direct Ignition Throttle  
Body Injection Pigtail  
GM 1987-On

UNIT PACKAGE: 2

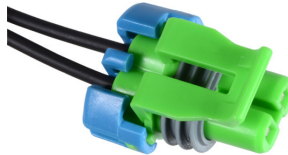

**18320**  
(12101856)

Air Switch Valve  
Harness Connector  
GM 1993-91

UNIT PACKAGE: 1



**17112**  
Not Supplied By O.E.M.

Distributor Module Pigtail  
Used on GM distributor  
module 1987466  
on 6 cylinder 2.8 engines  
1985-On

UNIT PACKAGE: 1



**18524**  
(12085497)

MAP Mass Air Flow Sensor  
Harness Connector  
GM with 2.8 Eng &  
Sequential Fuel Injection  
1989-85

UNIT PACKAGE: 1

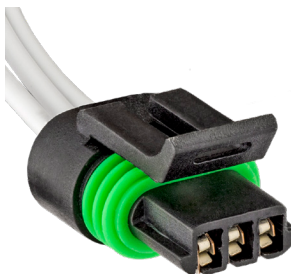

**18916**  
(12085483)

Ignition Module, Crankshaft  
Coolant Sensor & Power  
Steering Pressure Switch  
Harness Connector  
GM 1986-On

UNIT PACKAGE: 1



**18868**  
(12085495)

Mass Air Flow Sensor  
Harness Connector  
GM 1988-On

UNIT PACKAGE: 1

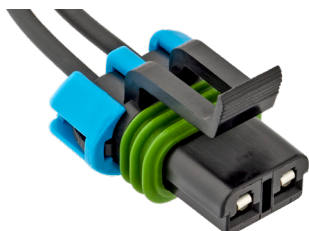

**18870**  
(12101855)

Direct Ignition  
Vehicle Speed Sensor  
Harness Connector  
GM  
1987-On

UNIT PACKAGE: 1

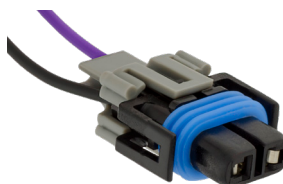

**16694**  
(12043215, 12085498)

Cornering & Fog Light Socket  
for 881 & H11 Halogen Bulbs  
GM

UNIT PACKAGE: 1

# GM SOCKET ASSEMBLY & HARNESS CONNECTORS

Sec. 12

Use with butt connectors on pages 205-211 • *Photos not actual size*



**21490**

(GM: 12102664,88862264)  
(Ford: 1U2Z-14S411-YA)

Fog & Front Lights, Power Steering & Oil Pressure Switch Harness Connector  
GM 2005 - 1986  
Ford 2004 - 1995  
Jeep Eagle 1994

UNIT PACKAGE: 1

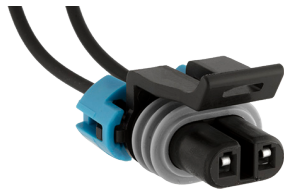

**17110**

(12102747)

Windshield Washer Pump, Low Coolant Sensor Harness Connector  
GM Cars & Trucks 1992-87

UNIT PACKAGE: 1

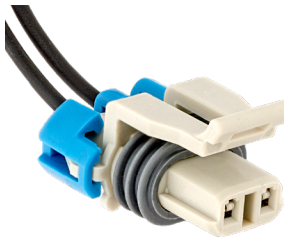

**17111**

(12116958)

Horn Harness Connector  
Fits Horns 1999160, 1999161, 10456327 and 10456328  
GM 1988-On

UNIT PACKAGE: 1



**21212**

(88988609)

Window Motor Regulator Harness Connector  
Two 12 Gauge  
10" Long Leads  
GM 1995 - On

UNIT PACKAGE: 1

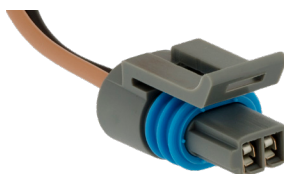

**16693**

(12046624, 12102620)

Replacement harness connector used with 1985-on GM Manifold

Air Temperature Sensors including 25036751. Features two 9" long 18 gauge wire leads.

UNIT PACKAGE: 1



**18917**

(12085538)

Camshaft Sensor Harness Connector  
Buick, Olds & Pontiac  
1992-86

UNIT PACKAGE: 1



**18925**

(25117765)

E.F.I. Fuel Pump Harness Connector  
GM with Fuel Pump in Gas Tank 1995-88

UNIT PACKAGE: 1

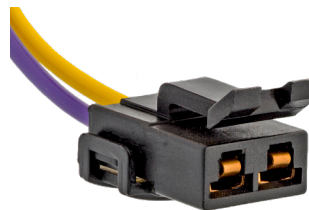

**19891**

(Not Available from O.E.M.)

Windshield Wiper Motor Harness Connector  
GM 1994 - 86

UNIT PACKAGE: 1

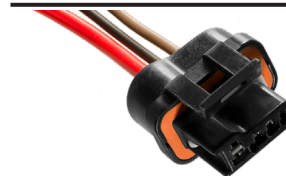

**17109**

(12085525, 12085527, 12085528, 12101895, 12117361)

3 Wire Alternator Harness Connector  
Two 18 gauge and one 12 gauge leads  
Can be used to replace two wire and single wire harness connectors by taping (do NOT cut) the appropriate unused leads.

GM 1986-On

UNIT PACKAGE: 1

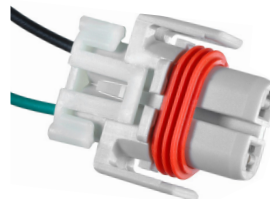

**21220**

(GM: 88987187)

Headlight Socket Harness Connector for H9 Halogen Bulb (Auveco Bulb No. BH9)

GM, Audi, Mazda, Mini-Cooper, Porsche, Volkswagen & Volvo

UNIT PACKAGE: 1



**17113**

(12101937)

A.C. Compressor Clutch Harness Connector  
GM Cars & APV 1989-On

UNIT PACKAGE: 1



**16514**

(12085503)

Replacement harness connector used on GM V-5 Air Conditioning Compressor Pressure Cut-off Switches. Fits GM low Pressure Switch 6551946 and others. Index slot is at three o'clock position. Features two 9" long 18 gauge wire leads

UNIT PACKAGE: 1

Use with butt connectors on pages 205-211 • *Photos not actual size*

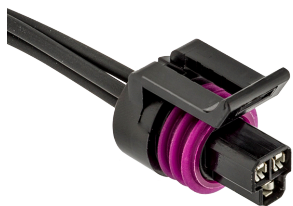

**18527**  
(12102748)

Throttle Position Sensor  
Harness Connector  
GM 1994-90

UNIT PACKAGE: 1



**14580**  
(12102621)

Radiator Fan Sensor Switch  
Harness Connector  
Fits electric cooling fan switches:  
3040674, 14043275 and 14043276  
GM 1980-On

UNIT PACKAGE: 1



**18674**  
(12126451)

Coolant Temperature  
Sensor Harness Connector  
Fits Sensor 10232601 & 25037203  
GM 1987-On

UNIT PACKAGE: 1



**17107**  
(12117385)

Oxygen Sensor  
Connector Pigtail

Fits the Following Oxygen Sensors:

- 8990469 (AC-Delco AFS13P)
  - 8990625 (AC-Delco AFS15P)
  - 8990741 (AC-Delco AFS16P)
  - 10042186 (AC-Delco 213-15)
  - 25105107 (AC-Delco AFS20)
  - 25105901 (AC-Delco AFS21)
  - 25106073 (AC-Delco AFS22)
- Most GM Models 1982-On

UNIT PACKAGE: 1



**16962**

(Not Supplied by O.E.M.)

Harness Connector used with GM  
Mixture Control Solenoid Kits:  
17067343, 17067344 and  
17111102 on  
2 & 4 barrel Rochester  
Varajet Carburetors.  
GM cars and trucks 1980-On

UNIT PACKAGE: 1



**19882**  
(12085485)

Back-Up Light Switch &  
Speed Sensor Harness Connector  
Used with Switch 23049569,  
PT107 & IACV Motor  
GM 1971-On

UNIT PACKAGE: 1

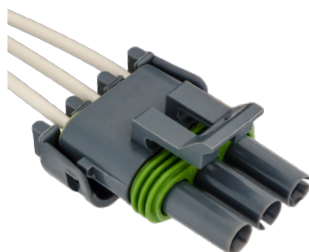

**16965**  
(12085507)  
Gray

Air Conditioner Pressure  
Switch Harness Connector  
Used on GM vehicles  
(28 models) 1988-84

UNIT PACKAGE: 1

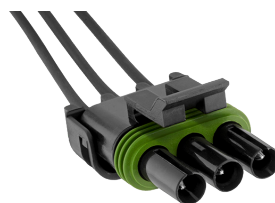

**17198**

(Not Supplied by O.E.M.)

Throttle Position Sensor  
Harness Connector  
Fits Sensor 17078051,  
17078448 & 17078481 on  
2 & 4 Barrel Rochester Carburetors  
GM 1990-80

UNIT PACKAGE: 1

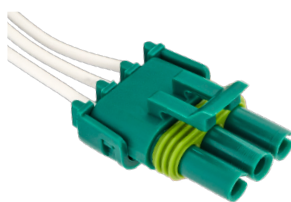

**16964**  
(12085502)  
Green

Manifold Absolute Pressure  
(MAP) Harness Connector.  
Fits GM MAP Sensor 6137039  
on GM vehicles (38 models)  
1982-on

UNIT PACKAGE: 1

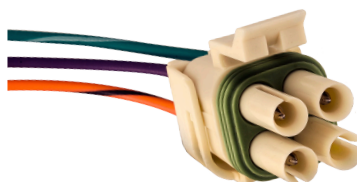

**17199**  
(12085533)

Transmission  
Converter Clutch  
Harness Connector

3 Wires (Cavity "C" is not wired)  
GM 1990-84

UNIT PACKAGE: 1



# GM SOCKET ASSEMBLY & HARNESS CONNECTORS

Use with butt connectors on pages 205-211 • *Photos not actual size*

**Sec. 12**



**18918**

(12085506)

Fuel Injection  
Idle Air Control Valve,  
Stoplight Switch & Torque  
Converter Clutch Valve  
Harness Connector  
GM 1985 - On

UNIT PACKAGE: 1



**16968**

(12085491)

Fuel Injector  
Solenoid Harness Connector  
Fits GM Multi-Port Fuel  
Injector 1711799 on 2.8  
and 3.1 liter engines  
(27 models) 1986 - On  
Fits Fuel Injectors on Ford,  
Chrysler & Imports (Bosch)

UNIT PACKAGE: 1

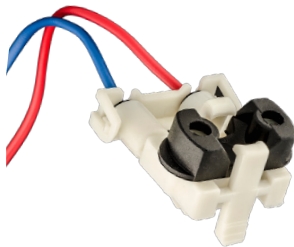

**17463**

(12102568)

Fuel Injector Connector for  
TBI (Throttle Body Injector)  
Systems  
All GM (Including  
Trucks) 1978 - On

UNIT PACKAGE: 1



**17690**

(12101903)

Washer Fluid Sensor  
Harness Connector  
Also used on Back-Up  
Light Switch & A.C. Compressor Switch  
GM 1985-On

UNIT PACKAGE: 5

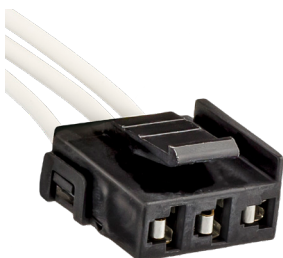

**19556**

(12117354)

Harness Connector  
Brake Light Switch 25529862  
GM: Camaro, Caprice,  
Century, Firebird, Lumina APV,  
K,S, & T Truck, Silhouette &  
Trans Sport 1991 - On

UNIT PACKAGE: 1



**18525**

(Not Supplied by O.E.M.)

Tail Light  
Harness Connector  
GM Full Size Pick-Up  
Trucks 1995 - 88

UNIT PACKAGE: 1

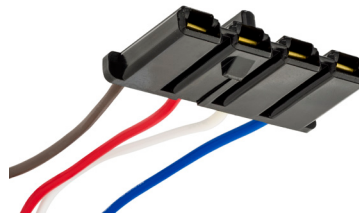

**11444**

Voltage Regulator  
Pigtail  
GM

UNIT PACKAGE: 10



**21033**

(88953358)

Harness Connector  
For Blower Motor Resistors 89019088, 89019089 &  
89019100 and Various Relays, Switches & Actuators  
8" Leads  
GM Cars and Light & Medium Duty Trucks 1990 - On

UNIT PACKAGE: 1



**21542**

(GM: 88953358)

Harness Connector with Seven 12 Gauge, 12" Leads  
For Blower Motor Resistors 89019088, 89019089 &  
89019100 and Various Relays, Switches & Actuators  
GM Cars and Light & Medium Duty Trucks 1990 - On

UNIT PACKAGE: 1

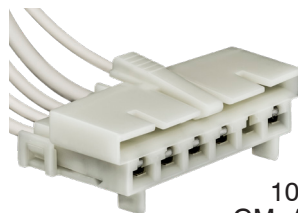

**19554**

(12101927)

Harness Connector Headlight  
and Ignition Switches  
15693540, 10471139,  
1070881, 26693547 & 15693548  
GM: Astro, Safari, C, K, S, T Trucks,  
Kodiak & Grand Am 1990-On

UNIT PACKAGE: 1



**11440**

(GM: 2962510)

Air Conditioner Blower Relay  
Harness Connector  
18 Gauge Wire  
GM, AMC & Chrysler

UNIT PACKAGE: 10

Use with butt connectors on pages 205-211 • *Photos not actual size*

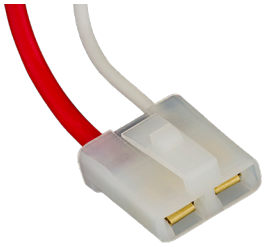

**11443**  
(6294493)

Alternator Harness Connector with Transistorized Alternators GM

UNIT PACKAGE: 10

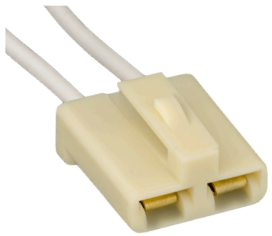

**17691**  
(12101909)

Alternator Harness Connector Two 16 Gauge Leads Fits Delcotron Models 10-SI, 12-SI, 15-SI & 27-SI with Internal Voltage Regulator GM 1980-71

UNIT PACKAGE: 5

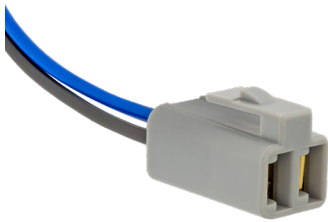

**11442**  
(2977373)

Alternator Harness Connector with External Voltage Regulators GM 1977-62

UNIT PACKAGE: 10



**13547**  
(2977373)

Alternator Extender Harness Connector with Female Connector GM 1974-62

UNIT PACKAGE: 2

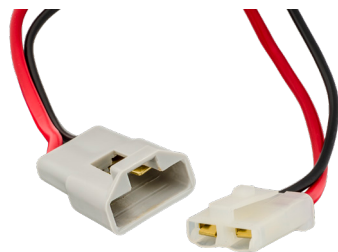

**13548**  
(6294493)

Alternator Extender Harness Connector with Female Connector GM 1971-On

UNIT PACKAGE: 2

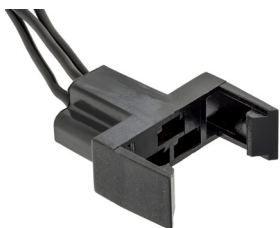

**11436**

Dimmer Switch Harness Connector GM

UNIT PACKAGE: 10

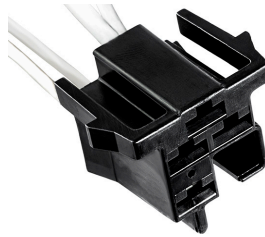

**19555**  
(12102757)

Harness Connector Headlight Dimmer Switch GM Most Models 1990-On

UNIT PACKAGE: 1

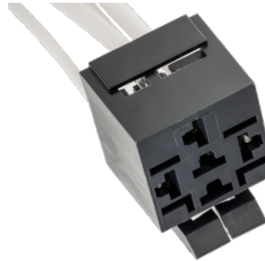

**18871**  
(12101939)

Harness Connector for Cooling Fan, Fuel Pump, Starter Interrupt Relay & Fan Control Switch Cadillac 1988-On

UNIT PACKAGE: 1

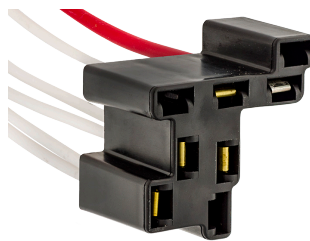

**18530**

(Not Supplied by O.E.M.)

Headlight Switch Harness Connector Fits Switch 1995217 GM 1991-68

UNIT PACKAGE: 1

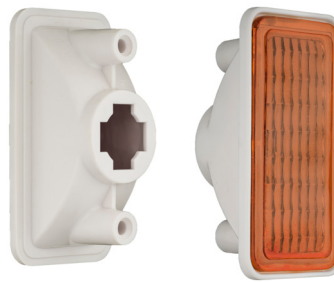

**9884**

(916638, 916581)  
Plastic

Amber Lens Front Fender Marker Lamp Assembly Use with Auveco 9883 GM

UNIT PACKAGE: 1



**9885**

(916638, 916581)  
Plastic

Clear Lens Front Fender Marker Lamp Assembly Use with Auveco 9883 GM

UNIT PACKAGE: 1

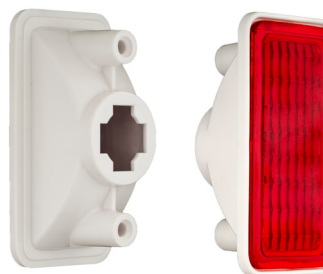

**9916**

(916632)  
Plastic

Red Lens Rear Quarter Marker Lamp Assembly Use with Auveco 9883 GM

UNIT PACKAGE: 1

Use with butt connectors on pages 205-211 • *Photos not actual size*



**12237**  
 (Chry: 3744750; GM: 12004311, 25015169; Ford: C80Z-13711A)  
 Instrument Panel Socket for 1/2" Hole  
 Bulb No. 194  
 GM, Ford & Chrysler

UNIT PACKAGE: 2

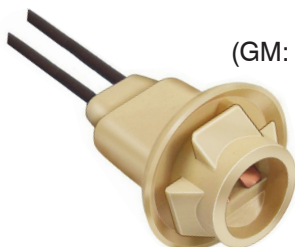

**9883**  
 (GM: 6298886, 6298892, 6298935; Ford: D0DZ-15A434B)  
 Side Marker Assembly  
 Bulb No. 158, 194, 194A  
 GM & Ford

UNIT PACKAGE: 5

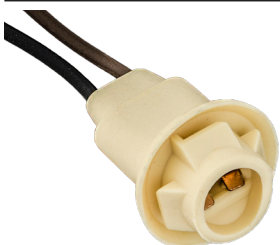

**11441**  
 Instrument Panel and  
 Marker Lights  
 Bulb No. 158, 194, 194A  
 GM & Ford

UNIT PACKAGE: 10

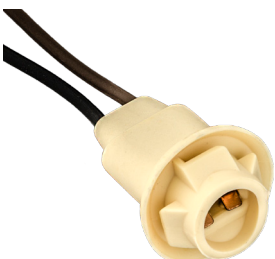

**11166**  
 (GM: 6294015, 8901283, 8918527; Ford: D40Z-13410E, D7AZ-13412A, D7FZ-13412A)  
 Side Marker &  
 License Plate Lights  
 Bulb No. 158, 194, 194A  
 GM & Ford

UNIT PACKAGE: 1



**8761**  
 License Plate & Instrument  
 Panel Lights  
 For 5/8" Hole  
 Bulb No. 51, 53, 55, 57 & 57X  
 Ford

UNIT PACKAGE: 10

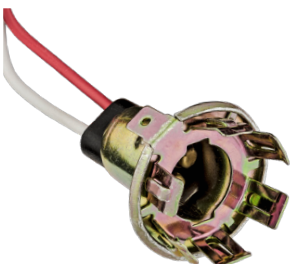

**13537**  
 (D1AZ-13410B)  
 Stop & Tail Lights  
 with one Ground Male  
 Blade Terminal  
 Bulb No. 1034, 1154 & 1157  
 Ford

UNIT PACKAGE: 1

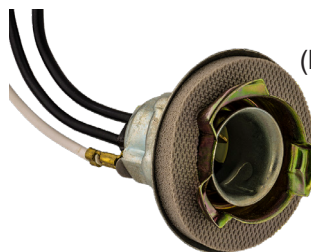

**13533**  
 (D3AZ-13410B, D5DZ-13410A)  
 Rear Lights  
 Bulb No. 1157  
 Ford

UNIT PACKAGE: 1



**13535**  
 (D3AZ-13410A)  
 Signal, Stop & Tail Lights  
 Bulb No. 1156  
 Ford

UNIT PACKAGE: 1

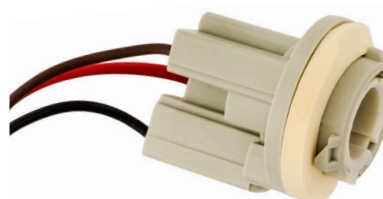

**14133**  
 (D4LY-13410-A)  
 Tail & Stop Lights  
 Bulb No. 1157  
 Ford

UNIT PACKAGE: 1

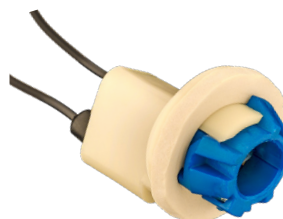

**14131**  
 (D3AZ-13410-E)  
 Back-up/Cornering Lights  
 Bulb No. 1141  
 Ford

UNIT PACKAGE: 1

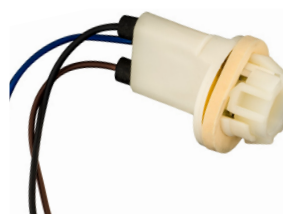

**14128**  
 (D40Z-13234-A)  
 Signal & Parking Lights  
 Bulb No. 1157  
 Ford

UNIT PACKAGE: 1

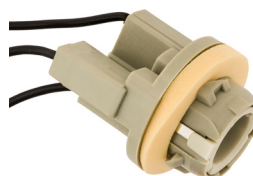

**14132**  
 (D3AZ-13410-G)  
 Tail & Stop lights  
 Bulb No. 1157  
 Ford

UNIT PACKAGE: 1



**14135**  
 (D1FZ-13234-A)  
 Parking Lights  
 Bulb No. 1157  
 Ford

UNIT PACKAGE: 1

Use with butt connectors on pages 205-211 • *Photos not actual size*

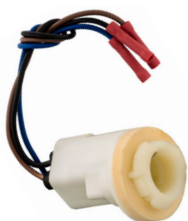

**14130**  
(D4ZZ-13234-A)

Signal & Parking Lights  
Bulb No. 1157  
Ford

UNIT PACKAGE: 1

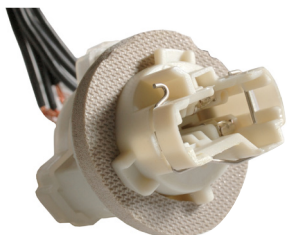

**20837**  
(Not Supplied by O.E.M.)

Stop & Tail Light  
Three 20 Gauge  
Wire Leads  
Uses 2458, 3057 &  
3157 Wedge Type Bulbs  
Ford 1987 - On

UNIT PACKAGE: 1



**20848**  
(Not Supplied by O.E.M.)

Rear Light Assembly  
Harness Connector  
Four 18 Gauge Wire Leads  
Ford F250 thru F750 without Pick Up Box 1999 - On

UNIT PACKAGE: 1

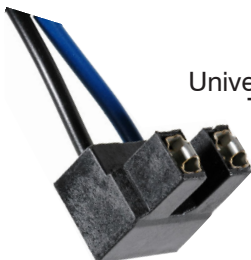

**21210**  
(Not Available from O.E.M.)

Universal Headlight Harness Connector  
Two 18 Gauge 6" Long Leads  
For H7 Halogen Bulbs  
Ford, Audi, BMW, Hyundai,  
Kia, Mazda, Mercedes,  
Mini Cooper, Saab & Subaru

UNIT PACKAGE: 1

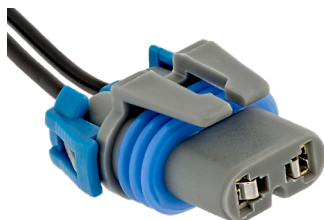

**16174**

Headlight Socket Assembly  
For Low Beam 9006  
Halogen Bulb  
Single Indexing Groove  
GM, Ford, AMC & Imports

UNIT PACKAGE: 4

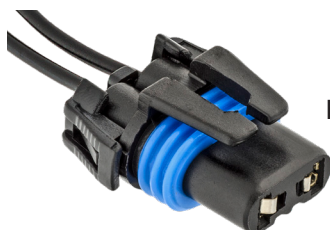

**16175**  
(GM: 12101898)

Headlight Socket Assembly  
For High Beam 9005  
Halogen Bulb  
Two Indexing Grooves  
GM, Ford, AMC & Imports

UNIT PACKAGE: 4



**21490**

(GM: 12102664, 88862264)  
(Ford: 1U2Z-14S411-YA)

Fog & Front Lights,  
Power Steering & Oil Pressure  
Switch Harness Connector  
GM 2005 - 1986  
Ford 2004 - 1995  
Jeep Eagle 1994

UNIT PACKAGE: 1



**14918**  
(12048369)

Headlight Socket Assembly  
For High-Low 9004 &  
9007 Halogen Bulb  
GM, Ford & Imports

UNIT PACKAGE: 1

## HAVE YOU VISITED US ONLINE?

**Auveco's website has been completely renovated.  
Our new design is user friendly with easy  
navigation and ordering.**

**Product is searchable by car make, OEM number  
and category, as well as, several attribute drop  
downs within individual categories. All product  
also has stock availability listed.**

**Make sure to head over to [www.auveco.com](http://www.auveco.com)  
to receive up to date information  
on all our products.**



**19890**

(Not Available from O.E.M.)

Back-Up Light Switch  
Harness Connector  
Fits Switches  
C9TZ-15520C & SW-849  
Ford Trucks & T-Bird 1967-On

UNIT PACKAGE: 1

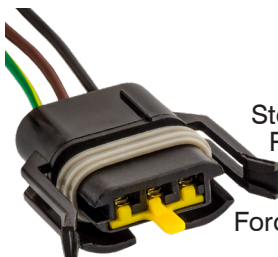

**19125**

(Not Supplied by O.E.M.)

Stop, Tail, Turn & Parking Lights  
Plugs into Light Socket Base  
For Double Filament  
Wedge Type Bulbs  
Ford Ranger, Explorer & Econoline  
1991-On

UNIT PACKAGE: 1

Use with butt connectors on pages 205-211 • *Photos not actual size*



## 22184

(Ford: F1TZ-13411-A;  
GM: 88860592)

Park, Stop & Turn Signal  
Lights Socket Base  
Bulb No. 3157  
Three Terminals  
Black Housing  
90° Angle Base

**Use with Auveco 19125**  
Ford Cars &  
Trucks 1994 - On

UNIT PACKAGE: 1

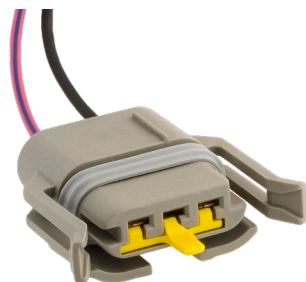

## 19126

(Not Supplied by O.E.M.)

Back-Up Lights Plugs into  
Light Socket Base  
For Single Filament  
Wedge Type Bulbs  
Ford Ranger, Explorer &  
Econoline 1991-On

UNIT PACKAGE: 1

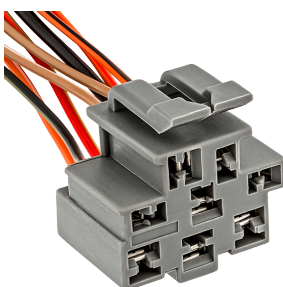

## 18463

(Not Supplied by O.E.M.)

Headlight Switch  
Harness Connector  
Fits Headlight Switches  
E6DZ-11654A & F2DZ-11654A  
Ford Taurus & Mercury Sable  
with Rotary Knob 1994-86

UNIT PACKAGE: 1

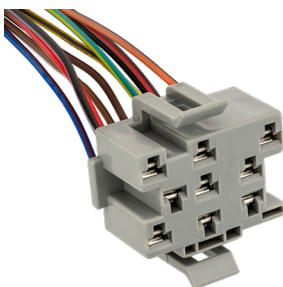

## 17624

(Not Supplied by O.E.M.)

Headlight Switch Assembly  
Harness Connector  
Fits Instrument Panel  
Headlight Switch  
E7TZ-11654-C  
Ford Trucks: F150, F250, F350  
& Bronco 1991-87

UNIT PACKAGE: 1

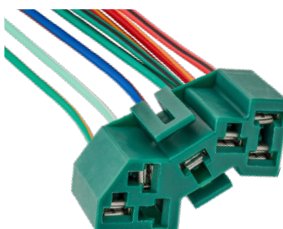

## 18464

(Not Supplied by O.E.M.)

Turn Signal Switch  
Harness Connector  
Fits Switch E7FZ-13341-A  
Ford Tempo, Topaz, EXP, LN7,  
Capri, Mustang, LTD, Marquis,  
Escort & Lynx 1994-85

UNIT PACKAGE: 1

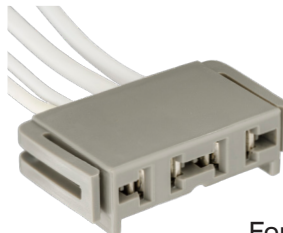

## 20547

(Not Supplied by O.E.M.)

Multi-Function Switch  
Harness Connector  
Fits 13K359 Switches E8DZ-B,  
E8ZZ-B, E9DZ-A,B,C, E90Y-D,  
E9SZ-B,D,E & F0ZZ-A,B  
Ford Taurus, Sable, T-Bird, Cougar  
and Continental 1993 - 86

UNIT PACKAGE: 1

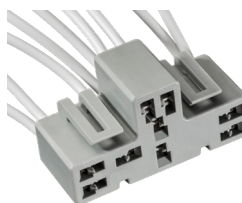

## 20548

(Not Supplied by O.E.M.)

Multi-Function Switch  
Harness Connector  
Fits 13K359 Switches E8DZ-B,  
E8ZZ-B, E9DZ-A, B, C, E90Y-D,  
E9SZ-B, D, E & F0ZZ-A, B  
Ford Taurus, Sable, T-Bird, Cougar and  
Continental 1993 - 86

UNIT PACKAGE: 1

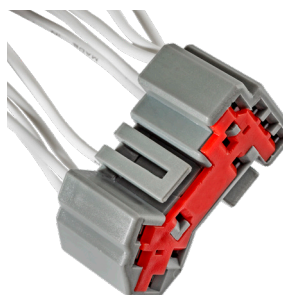

## 20246

(Not Supplied by O.E.M.)

Multi-Function Switch  
Repair Harness  
Eleven 18 Gauge Leads  
Aerostar, E Van, Expedition,  
Mustang, Navigator, Sable,  
Taurus & Windstar 1992 - On

UNIT PACKAGE: 1

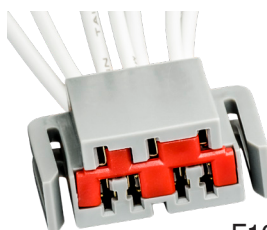

## 20550

(Not Supplied by O.E.M.)

Multi-Function Switch  
Harness Connector  
Fits 13K359 Switches  
F1AZ-A, B, F1DZ-B, F1LY-B,  
F10Y-D, F1VY-C, F3TZ-B, F3UZ-C,  
F4ZZ-AA, F58Z-A, F5AZ-A, F5TZ-B, F65Z-AA, F6DZ-A,  
F75Z-AB,AC,BA, F77Z-AA, F79Z-CA & F85Z-AA  
Ford Aerostar, Bronco, Continental, Cougar,  
Expedition, Explorer, F Pick-Ups, Mark Series,  
Mountaineer, Mustang, Navigator, Ranger, Sable,  
T-Bird, Taurus, Town Car & Windstar 1990 - On

UNIT PACKAGE: 1



## 18673

(Not Supplied by O.E.M.)

Multi-Function Switch  
Harness Connector  
(Turn Signal & Windshield Wiper)  
Fits Switch E9DZ-13K359-A, B, C,  
E8ZZ-13K359-B & F0ZZ-13K359-A  
Ford Mustang 1993-87  
Taurus & Sable 1989-86

UNIT PACKAGE: 1

Use with butt connectors on pages 205-211 • *Photos not actual size*

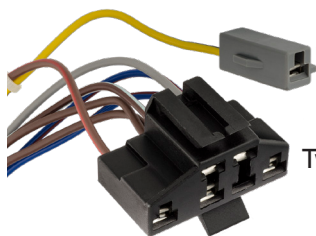

**17623**

(Not Supplied by O.E.M.)

EEC IV Test Plug  
Repair Harness Connector  
Two Connectors with eight 18  
Gauge Leads  
Ford 1983-On

UNIT PACKAGE: 1

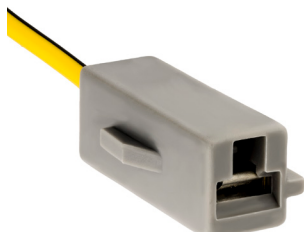

**19581**

(Not Supplied by O.E.M.)

EEC IV Test Plug  
Repair Harness Connector  
One 18 Gauge Wire Lead  
**Component of Auveco  
17623 Harness Connector**  
Ford 1983-On

UNIT PACKAGE: 5



**19881**

(Not Supplied by O.E.M.)

Ignition Switch  
Harness Connector  
Used with Switches  
D0TZ-11572A, SW944  
Ford Trucks: 100-900 Series  
1970-On

UNIT PACKAGE: 1



**20853**

(Not Supplied by O.E.M.)

Ignition Coil  
Harness Connector  
Two 16 Gauge Wire Leads  
Fits Coils F7TZ-12029-CC &  
1L2Z-12029-AA  
Ford Cars & Lt. Duty Trucks  
1999 - On

UNIT PACKAGE: 1

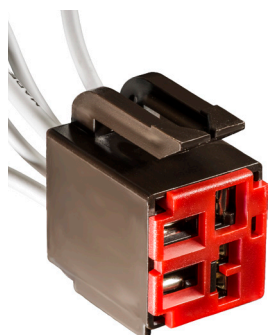

**20172**

(Not Supplied by O.E.M.)

EEC Relay Harness Connector  
Used with Relay E3AZ-12A646-A  
Two 18 Gauge Wire Leads,  
Two 16 Gauge Wire Leads &  
One 14 Gauge Wire lead  
Ford Cars & Trucks 1981-On

UNIT PACKAGE: 1



**20844**

(Not Supplied by O.E.M.)

Electronic  
Ignition Module  
Harness Connector  
Four 16 Gauge Wire Leads  
Fits Modules  
F2PZ-12A199-AA, DY683  
Ford 1975 - On

UNIT PACKAGE: 1



**20841**

(Not Supplied by O.E.M.)

Electronic  
Ignition Module  
Harness Connector  
Four 18 Gauge Wire Leads  
Fits Module F2PZ-12A199-AA, DY683  
Ford Cars & Lt. Trucks 1985 - 75  
700 Series & Larger 1991 - 75

UNIT PACKAGE: 1

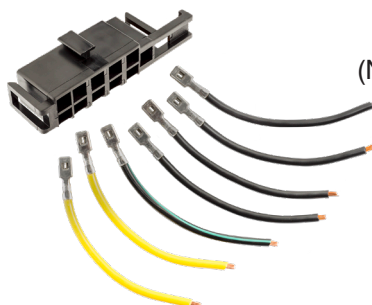

**17684**

(Not Supplied by O.E.M.)

Ignition Switch  
Harness Connector  
Fits Ignition Switch  
E6FZ-11572A  
Ford 1992-80

UNIT PACKAGE: 1

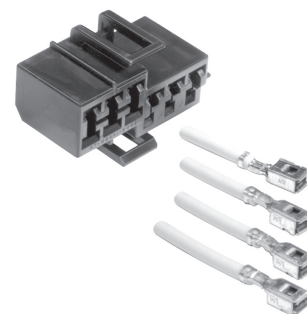

**18676**

(E6DZ-14A411-A)

Ignition Switch  
Harness Connector  
Fits Switch E7DZ-11572-A  
Ford Taurus, Sable &  
Lincoln Continental  
1986-On

UNIT PACKAGE: 1



**18214**

(Not Supplied by O.E.M.)

Ignition Module  
Harness Connector  
Fits Ignition Module  
E8TZ-12A297A  
Ford Ranger: 1995-88

UNIT PACKAGE: 1

Use with butt connectors on pages 205-211 • *Photos not actual size*

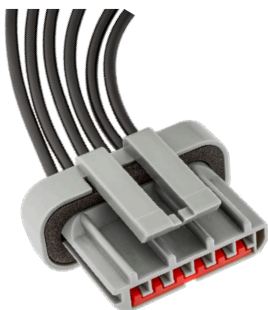

**18217**  
(E5ZZ-12A209A)

Ignition Module &  
Neutral Safety Switch  
Harness Connector  
For E.E.C. IV Ignition 1995-83  
Ford Neutral Safety Switch  
E80Z-7A247-A 1988-On

UNIT PACKAGE: 1



**18819**  
(Not Supplied by O.E.M.)

Heater & Air Conditioner  
Blower Switches  
Harness Connector  
Fits most Ford Switches with  
Base Number 19986  
1973-On

UNIT PACKAGE: 1

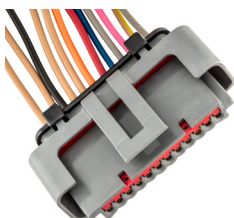

**19623**  
(Not Supplied by O.E.M.)

Ignition Control Module Harness  
For Modules F1AZ,  
F4SZ-12072A & F5SZ-12072AA  
Wire Gauge: 5 of 18 & 7 of 16  
8" Leads  
Ford: Full Size Trucks & Vans, T-Bird,  
Cougar Lincoln Town & Mark 1991 - On

UNIT PACKAGE: 1

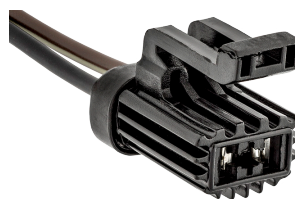

**19582**  
(Not Supplied by O.E.M.)

Harness Connector for  
Heater Blower Motor &  
Radiator Cooling Fan Motor  
**Replaces Auveco 18213**  
Ford Truck & Vans 1986-82  
Ford 4-Cylinder Engine  
1979-On

UNIT PACKAGE: 5

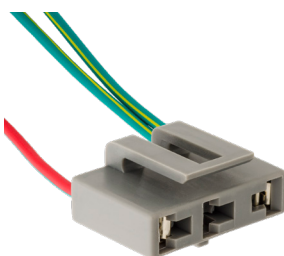

**17661**  
(Not Supplied by O.E.M.)

Electronic Ignition Coil  
Harness Connector  
Fits Coil E73Z-12029A  
Ford 1986-On

UNIT PACKAGE: 1

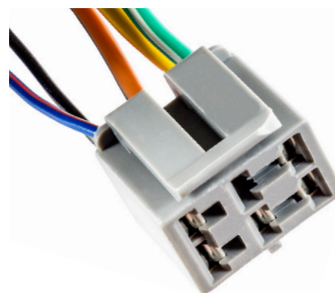

**19883**  
(Not Supplied by O.E.M.)

Blower Motor Switch  
Harness Connector  
Used with Switch  
E83Z-19986A, YH-481  
Tempo & Topaz 1994-88

UNIT PACKAGE: 1

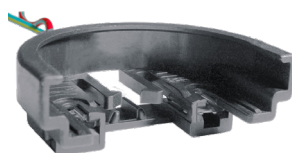

**20839**  
(Not Supplied by O.E.M.)

Coil to Ignition  
Harness Connector  
Two 18 Gauge Wire Leads  
Ford 1977 - On

UNIT PACKAGE: 10

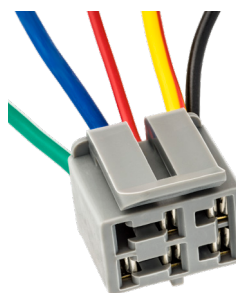

**19887**  
(Not Supplied by O.E.M.)

Auxiliary Blower Switch  
Harness Connector  
Fits Switch F2UZ-19986C, YH-538  
Ford Vans E150/350 1992-On

UNIT PACKAGE: 1

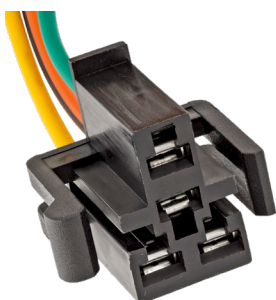

**17620**  
(Not Supplied by O.E.M.)

Air Conditioning Blower  
Motor Resistor Assembly  
Harness Connector  
Fits Resistor Assembly  
E7TZ-19A706-A  
Ford Trucks 1983 - On

UNIT PACKAGE: 1



**20849**  
(Not Supplied by O.E.M.)

Blower Motor Switch  
Harness Connector  
Five 16 Gauge Wire Leads  
Fits Switches D0HZ-19986-A, YH411  
Ford Heavy Duty Trucks 1989 - 1968

UNIT PACKAGE: 1

Use with butt connectors on pages 205-211 • *Photos not actual size*



**17598**

(Not Supplied by O.E.M.)  
Air Conditioning Clutch  
Cycling Pressure Switch  
Harness Connector  
Fits Switch E35Y-19E561-A  
Ford 1980-On

UNIT PACKAGE: 1

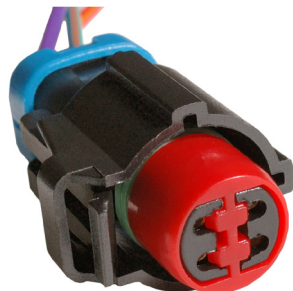

**20843**

(F81Z-19D887-AA, WPT-169,  
1U2Z-14S411-AEA)  
A/C Clutch Cycling  
Pressure Switch  
Harness Connector  
Four 16 Gauge Wire Leads  
Fits Switches F5VY-19E561-A,  
F3AZ-19D594-C,  
F5TZ-19D594-AA & YH-592  
Ford 1990 - On

UNIT PACKAGE: 1



**17617**

(Not Supplied by O.E.M.)  
Gray  
Engine Cooling Fan  
Motor Switch  
Harness Connector  
Fits Switch E43Z-8B607-A  
Ford 1984-On

UNIT PACKAGE: 1



**17618**

(Not Supplied by O.E.M.)  
Black  
Engine Cooling Fan  
Motor Switch  
Harness Connector  
Fits Switches E5SZ-8B607-A &  
E4FZ-8B607-A  
Ford 1984-On

UNIT PACKAGE: 1



**19661**

(Not Supplied by O.E.M.)  
Blower Motor Resistor  
Harness Connector  
Fits Resistors F1CZ-19A706-A  
& F7CZ-19A706-AA  
One Connector has one each of  
8" Long 20 Gauge, 16 Gauge, 14  
Gauge & 12 Gauge GXL Wire Leads.  
The other Connector has one 8" Long  
12 Gauge GXL Wire Lead.  
Ford Escort & Tracer 1991-On

UNIT PACKAGE: 1



**22185**

(Ford: 1U2Z-14S411-BHA,  
WPT-153)  
Blower Motor Resistor  
Harness Connector  
Two 10 Gauge &  
Three 20 Gauge  
TXL Wire Leads  
Ford, Lincoln &  
Mercury 2011 - 1991

UNIT PACKAGE: 1

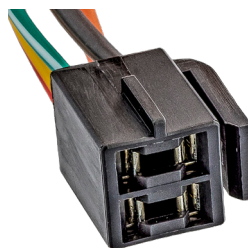

**20277**

(Not Supplied by O.E.M.)  
Heater/Air Conditioner  
Fan Speed Switch  
Harness Connector  
Two 12 Gauge, one 14 Gauge &  
One 16 Gauge Leads  
Fits Switches E6DZ-A, E9SZ-A,  
F2DZ-A & F2UZ-19986A,B  
Ford Cougar, E Van, Mustang, Sable,  
Taurus & T-Bird 1986 - On

UNIT PACKAGE: 1

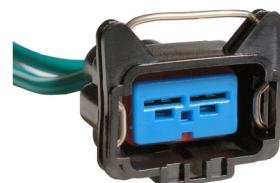

**20852**

(Not Supplied by O.E.M.)  
Radiator Cooling  
Motor & Resistor  
Harness Connector  
Two 12 Gauge Leads  
For Resistor F5RZ-8L603-AC &  
Motors F8RZ-8C607-GC, GE, RF28, RF76 & RF81  
Ford Contour, Mystique & Cougar 1995 - On

UNIT PACKAGE: 1

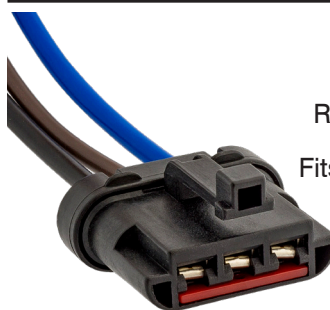

**20549**

(Not Supplied by O.E.M.)  
Radiator Cooling Fan Motor  
Harness Connector  
Fits Fan & Shroud Assemblies  
F4DZ-8C607B &  
F5CA-8C607A  
Ford Contour, Continental,  
Escort, Mystique,  
Sable & Taurus 1997 - 90

UNIT PACKAGE: 1

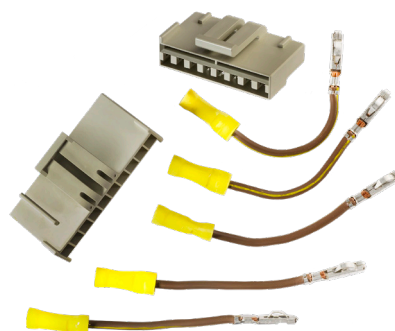

**17619**

(E4FZ-8C290-A)

Engine Cooling Fan  
Harness Connector  
Wiring Kit  
Ford 4 Cylinder  
(2.3 Engine)  
with Air Conditioning  
1983-On

UNIT PACKAGE: 1



Use with butt connectors on pages 205-211 • *Photos not actual size*

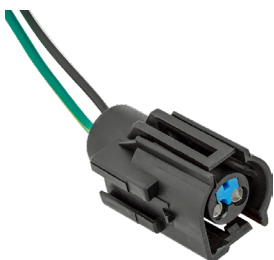

**17683**  
(Not Supplied by O.E.M.)

Coolant Temperature Sensor  
Harness Connector  
Fits Sensor E1AZ-12A648A  
Ford 1981-On

UNIT PACKAGE: 1



**17621**  
(Not Supplied by O.E.M.)

Windshield Washer  
Pump Harness Connector  
Fits Pumps E0AZ-17664-A  
& E30Z-17664-A  
Ford 1968 - On

UNIT PACKAGE: 1

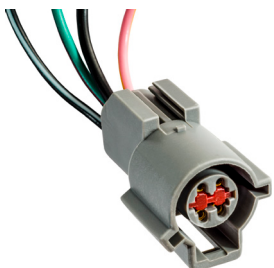

**18216**  
(Not Supplied by O.E.M.)  
Gray Shell

Exhaust Oxygen Sensor  
Harness Connector  
Fits Sensors F0TZ-9F472-A & C,  
F09Z-9F472-A & C,  
F1SZ-9F472-A & F1UZ-9F472-C  
Ford 1995-89

UNIT PACKAGE: 1

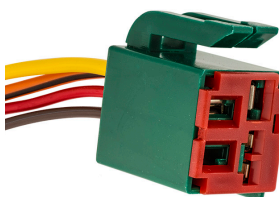

**17622**  
(Not Supplied by O.E.M.)

Fuel Pump Relay Assembly  
Harness Connector  
Fits Relay Assembly  
E3FZ-9345-B  
Ford 1983 - On

UNIT PACKAGE: 1

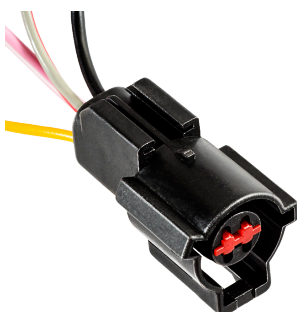

**18215**  
(Not Supplied by O.E.M.)  
Black Shell

Exhaust Oxygen Sensor  
Harness Connector  
Fits Sensors  
F0SZ-9F472-A & B,  
F0TZ-9F472-B & E,  
F02Z-9F472-C &  
F03Z-9F472-A  
Ford 1995-89

UNIT PACKAGE: 1



**20842**  
(Not Supplied by O.E.M.)

Fuel Injectors  
Harness Connector  
One 16 Gauge &  
One 18 Gauge Wire Leads  
with Oval Injector Connectors  
Ford 1999 - On

UNIT PACKAGE: 1

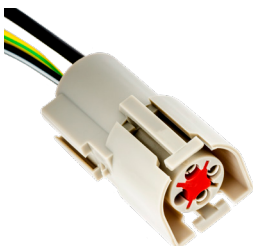

**19889**  
(Not Supplied by O.E.M.)

Exhaust Oxygen Sensor  
Harness Connector  
Used with 3 Wire O2 Sensors  
(Base No. 9F472)  
Ford 1986-On

UNIT PACKAGE: 1



**16968**  
(12085491)

Fuel Injector  
Solenoid Harness Connector  
Fits GM Multi-Port Fuel  
Injector 1711799 on 2.8  
and 3.1 liter engines  
(27 models) 1986 - On  
Fits Fuel Injectors on Ford,  
Chrysler & Imports (Bosch)

UNIT PACKAGE: 1

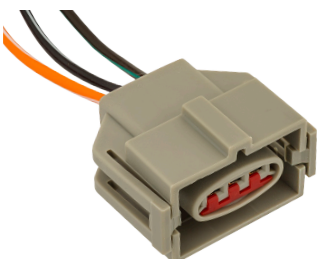

**17662**  
(Not Supplied by O.E.M.)

EGR Sensor  
Harness Connector  
Fits Sensor E6AZ-9J460-A  
Ford Escort, Lynx, Sable &  
Taurus 1988 - On

UNIT PACKAGE: 1

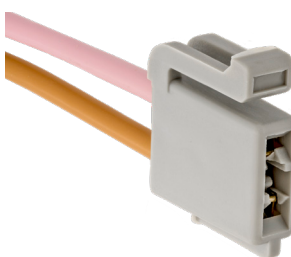

**18671**  
(Not Supplied by O.E.M.)

Air Conditioner  
Clutch Field Coil  
Harness Connector  
Ford

UNIT PACKAGE: 10



**19156**  
(Not Supplied by O.E.M.)

Alternator Regulator &  
Air Conditioner Clutch Field  
Harness Connector  
Ford 1994-On

UNIT PACKAGE: 10